

DATA SHEET

MODULETEK: SFP-GE-CWDM-xxxx-32DB-x-G10

1.25Gb/s SFP (Small Form Pluggable) CWDM(1270nm-1610nm) Transceiver

SFP-GE-CWDM-xxxx-32DB-x-G10 Overview

ModuleTek's SFP-GE-CWDM-xxxx-32DB-x-G10 SFP optical transceivers are designed for Gigabit Ethernet and Fibre Channel network equipment, they are available in 18 different CWDM wavelengths, from 1270nm to 1610nm. The product implements digital diagnostics via a 2-wire serial bus, compliant with the INF-8074i Small Form Factor Pluggable Multi-Source Agreement (MSA) and SFF-8472 standard.

Product Features

- Up to 1.25Gb/s bi-directional data links
- Compliant with IEEE 802.3z Gigabit Ethernet standard
- Compliant with Fiber Channel 100-SM-LL-V standard
- Compliant with SFP MSA
- Compliant with SFF-8472
- Hot-Pluggable
- Temperature-stabilized CWDM laser
- Receiver with APD
- Duplex LC connector
- Built-in digital diagnostic functions
- Up to 120km on SMF
- Single power supply 3.3V
- RoHS Compliant
- Operating temperature range (Case Temperature) : Commercial Level : 0°C to 70°C
Industrial Level : -40°C to 85°C



Applications

- 1.25Gb/s Gigabit Ethernet
- 1.063Gb/s Fiber Channel

Ordering Information

Part Number	Product ID	Description
SFP-GE-CWDM-xxxx-32DB-C-G10	M009704	GE/FC CWDM SFP Transceiver, LC Connectors, Commercial temperature
SFP-GE-CWDM-xxxx-32DB-I-G10	M009705	GE/FC CWDM SFP Transceiver, LC Connectors, Industrial temperature
Note: 1.Product ID is the abbreviated order number of our company's standard model		

For More Information:

ModuleTek Limited

Web : www.moduletek.com

Email : sales@moduletek.com

Product Selection

Part Number	Description	Color on Clasp
SFP-GE-CWDM-1270-32DB-x-G10	GE CWDM SFP Transceiver, LC Connectors, 1270nm, Single Mode Fiber 100km	Light purple
SFP-GE-CWDM-1290-32DB-x-G10	GE CWDM SFP Transceiver, LC Connectors, 1290nm, Single Mode Fiber 100km	Sky blue
SFP-GE-CWDM-1310-32DB-x-G10	GE CWDM SFP Transceiver, LC Connectors, 1310nm, Single Mode Fiber 100km	Yellow green
SFP-GE-CWDM-1330-32DB-x-G10	GE CWDM SFP Transceiver, LC Connectors, 1330nm, Single Mode Fiber 100km	Yellow ocher
SFP-GE-CWDM-1350-32DB-x-G10	GE CWDM SFP Transceiver, LC Connectors, 1350nm, Single Mode Fiber 100km	Pink
SFP-GE-CWDM-1370-32DB-x-G10	GE CWDM SFP Transceiver, LC Connectors, 1370nm, Single Mode Fiber 100km	Beige
SFP-GE-CWDM-1390-32DB-x-G10	GE CWDM SFP Transceiver, LC Connectors, 1390nm, Single Mode Fiber 100km	White
SFP-GE-CWDM-1410-32DB-x-G10	GE CWDM SFP Transceiver, LC Connectors, 1410nm, Single Mode Fiber 100km	Silver
SFP-GE-CWDM-1430-32DB-x-G10	GE CWDM SFP Transceiver, LC Connectors, 1430nm, Single Mode Fiber 100km	Black
SFP-GE-CWDM-1450-32DB-x-G10	GE CWDM SFP Transceiver, LC Connectors, 1450nm, Single Mode Fiber 100km	Yellow orange
SFP-GE-CWDM-1470-32DB-x-G10	GE CWDM SFP Transceiver, LC Connectors, 1470nm, Single Mode Fiber 120km	Gray
SFP-GE-CWDM-1490-32DB-x-G10	GE CWDM SFP Transceiver, LC Connectors, 1490nm, Single Mode Fiber 120km	Purple

SFP-GE-CWDM-1510-32DB-x-G10	GE CWDM SFP Transceiver, LC Connectors, 1510nm, Single Mode Fiber 120km	Blue
SFP-GE-CWDM-1530-32DB-x-G10	GE CWDM SFP Transceiver, LC Connectors, 1530nm, Single Mode Fiber 120km	Green
SFP-GE-CWDM-1550-32DB-x-G10	GE CWDM SFP Transceiver, LC Connectors, 1550nm, Single Mode Fiber 120km	Yellow
SFP-GE-CWDM-1570-32DB-x-G10	GE CWDM SFP Transceiver, LC Connectors, 1570nm, Single Mode Fiber 120km	Orange
SFP-GE-CWDM-1590-32DB-x-G10	GE CWDM SFP Transceiver, LC Connectors, 1590nm, Single Mode Fiber 120km	Red
SFP-GE-CWDM-1610-32DB-x-G10	GE CWDM SFP Transceiver, LC Connectors, 1610nm, Single Mode Fiber 120km	Brown

General Specifications

Parameter	Symbol	Min	Typ	Max	Unit	Remarks
Data Rate	DR	0.622		1.25	Gb/s	
Bit Error Rate	BER			10^{-12}		
Operating Temperature	T _C	0		70	°C	1, 4
	T _I	-40		85	°C	1, 5
Storage Temperature	T _{STO}	-40		85	°C	2
Supply Current	I _S		200	300	mA	3
Input Voltage	V _{CC}	3.14	3.3	3.46	V	
Maximum Voltage	V _{MAX}	-0.5		4	V	3

Notes:

1. Case temperature
2. Ambient temperature
3. For electrical power interface
4. Commercial temperature
5. Industrial temperature

Optical – Characteristics – Transmitter

$V_{CC}=3.14V$ to $3.46V$, $T_C=0^{\circ}C$ to $70^{\circ}C$

Parameter	Symbol	Min	Typ	Max	Unit	Remarks
Output Optical Power	P_{TX}	0		5	dBm	1
Optical Center Wavelength –1270nm	λ_C	1265	1271	1277	nm	
Optical Center Wavelength –1290nm		1285	1291	1297	nm	
Optical Center Wavelength –1310nm		1305	1311	1317	nm	
Optical Center Wavelength –1330nm		1325	1331	1337	nm	
Optical Center Wavelength –1350nm		1345	1351	1357	nm	
Optical Center Wavelength –1370nm		1365	1371	1377	nm	
Optical Center Wavelength –1390nm		1385	1391	1397	nm	
Optical Center Wavelength –1410nm		1405	1411	1417	nm	
Optical Center Wavelength –1430nm		1425	1431	1437	nm	
Optical Center Wavelength –1450nm		1445	1451	1457	nm	
Optical Center Wavelength –1470nm		1465	1471	1477	nm	
Optical Center Wavelength –1490nm		1485	1491	1497	nm	
Optical Center Wavelength –1510nm		1505	1511	1517	nm	
Optical Center Wavelength –1530nm		1525	1531	1537	nm	
Optical Center Wavelength –1550nm		1545	1551	1557	nm	
Optical Center Wavelength –1570nm		1565	1571	1577	nm	
Optical Center Wavelength –1590nm		1585	1591	1597	nm	
Optical Center Wavelength –1610nm		1605	1611	1617	nm	
Extinction Ratio	ER	9			dB	
Spectral Width(-20dB)	$\Delta\lambda$			1	nm	
Side Mode Suppression Ratio	SMSR	30			dB	
Optical Rise/Fall Time(20%-80%)	t_r/t_f			180	ps	
Relative Intensity Noise	RIN			-120	dB/Hz	
Transmitter Jitter (peak to peak)	TJ			100	ps	
Output Optical Eye	Compatible with IEEE 802.3					

Notes:

1.Average Launch Power

Typical eye diagram

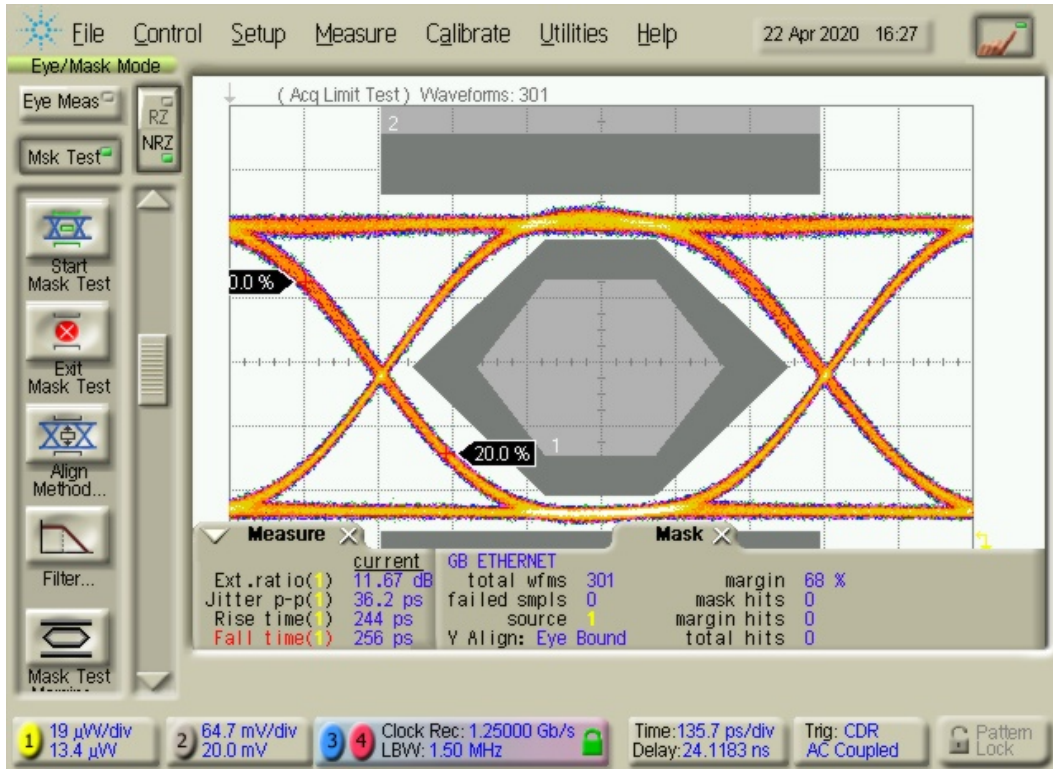

Optical – Characteristics – Receiver

$V_{CC}=3.14V$ to $3.46V$, $T_C=0^{\circ}C$ to $70^{\circ}C$

Parameter	Symbol	Min	Typ	Max	Unit	Remarks
Optical Center Wavelength	λ_C	1270		1620	nm	
Receiver Sensitivity	R_{X_SEN}			-32	dBm	1
Receiver Overload	P_{OL}	-9			dBm	
LOS Assert	LOS_A	-42			dBm	
LOS De-Assert	LOS_D			-32	dBm	
LOS Hysteresis	LOS_H	0.5			dB	

Notes:

1. Measured with a 2⁷-1 test pattern, Over 120km@1.25GB/s, BER<10⁻¹²

Electrical – Characteristics – Transmitter

$V_{CC}=3.14V$ to $3.46V$, $T_C=0^{\circ}C$ to $70^{\circ}C$

Parameter	Symbol	Min	Typ	Max	Unit	Remarks
Input differential impedance	R_{IN}		100		Ω	
Single ended data input swing	V_{IN_PP}	250		1200	mV	
Transmit disable voltage	V_D	$V_{CC}-1.3$		V_{CC}	V	
Transmit enable voltage	V_{EN}	V_{EE}		$V_{EE}+0.8$	V	
Transmit disable assert time				10	us	

Electrical – Characteristics – Receiver

$V_{CC}=3.14V$ to $3.46V, T_C=0^{\circ}C$ to $70^{\circ}C$

Parameter	Symbol	Min	Typ	Max	Unit	Remarks
Single ended data output swing	V_{OUT_PP}	300	400	800	mV	
Data output rise/fall time	t_r/t_f		100	175	ps	
LOS asserted	V_{LOS_A}	$V_{CC}-0.5$		V_{CC_HOST}	V	
LOS de-asserted	V_{LOS_D}	V_{EE}		$V_{EE}+0.5$	V	

A0/A2 Write Protection

Security Level 1 Password		
Password Entry Addr	Size	Vaules(hex)
Page A2, 7BH-7EH	4	00 00 10 11

This module has the A0 / A2 write protection function. The user can enter the security level 1 working state and write the contents of Table 00 and Table 01 of the device address A0H and A2H of the module. The method to enter the working state of security level 1 is to write the security level 1 password in order in the 7BH-7EH registers of A2H of the module. After entering security level 1, the user can directly write to the contents of the A0H device address, or modify the contents of the A2H 7F table selection register to write to the contents of Table 00 or Table 01. This version of the module does not support users to modify the password of security level 1. If you need to modify the security level 1 password, you must notify our company to modify it before shipping.

A0H Device register description

IIC Site	Byte size	Register name	Register description	Value(HEX)
0	1	Identifier	SFP	03
1	1	Extended Identifier	Use the IIC interface	04
2	1	Connector	Use the LC connector	07
3-10	8	Transceiver	1000 Base LX	00 00 00 02 00 00 01 01
11	1	Encoding	Use the 8B/10B coding scheme	01
12	1	BR, Nominal	1.25Gb/s nominal rate	0D
13	1	Rate Identifier	No rate selection	00
14	1	Length(9 μ m)-km	In single-mode fiber transmission 120km	78
15	1	Length (9 μ m)-100m	In single-mode fiber transmission 120km	FF
16	1	Length (50 μ m)-10m	The transmission distance in the multimode fiber	00
17	1	Length (62.5 μ m)-10m	The transmission distance in the multimode fiber	00
18	1	Length (Copper)	The transmission distance over the copper cable	00
19	1	Reserved	Undefined	00
20-35	16	Trade name	MODULETEK	ASCII Format
36	1	Transceiver	Undefined	00
37-39	3	Vendor OUI	Vendor IEEE company ID	00 00 00
40-55	16	Vendor PN	Vendor's product model	Vendor defined
56-59	4	Vendor Revision Number	Vendor's product version number	Vendor defined
60-61	2	Wavelength	According to the actual wavelength of the laser	According to the actual wavelength of the laser
62	1	Reserved	Undefined	00
63	1	CC_BASE	0-62 Check and of bytes	Vendor defined
64-65	2	Transceiver Options	1.Rx_LOS Sigal monitoring 2.Tx_FAULT Sigal monitoring 3.Tx_DIS Sigal monitoring	00 1A
66	1	BR, max	High bit rate margin	00
67	1	BR, min	Low bit rate margin	00
68-83	16	Vendor SN	Vendor serial number	Vendor defined
84-91	8	Date code	The date code	Vendor defined

92	1	Monitoring Type	DOM Information internal calibration The received light power is measured using the average light power	68
93	1	Enhanced Options	1. Emitting light and receiving light alarm and warning monitoring 2. Tx_DIS Signal monitoring and control 3. Rx_LOS Signal monitoring 4. Tx_FAULT Signal monitoring	F0
94	1	Compliance	As defined in SFF-8472 in version 12.0	08
95	1	CC_EXT	64-94 Check and bytes	Vendor defined
96-127	32	Vendor Specific	Vendor custom areas	Vendor defined
128-255	128	Vendor Specific	Vendor custom areas	Vendor defined

Digital Diagnostic Functions

SFP-GE-CWDM-xxxx-32DB-x-G10 supports the 2-wire serial communication protocol as defined in SFP MSA. Digital diagnostic information is accessible over the 2-wire interface at the address 0xA2. Digital diagnostics for SFP-GE-CWDM-xxxx-32DB-x-G10 are internally calibrated by default. The internal micro control unit accesses the device operating parameters in real time, such as transceiver temperature, laser bias current, transmitted optical power, received optical power and transceiver supply voltage. The module implements the alarm function of the SFP MSA, alerts the user when a particular operating parameter exceeds the factory-set normal range.

Diagnostic Threshold Range					
Parameter		High Alarm(hex)	High Warning(hex)	Low Warning(hex)	Low Alarm(hex)
Temperature (°C)	C	75 (0x4B00)	70 (0x4600)	0 (0x0000)	-5 (0xFB00)
	I	90 (0x5A00)	85 (0x5500)	-40 (0xD800)	-45 (0xD300)
Voltage (V)		3.63 (0x8DCC)	3.46 (0x8728)	3.13 (0x7A44)	2.97 (0x7404)
Bias Current (mA)		100 (0xC350)	80 (0x9C40)	4 (0x07D0)	2 (0x03E8)
Tx Power (dBm)		5.79(0x943B)	5 (0x7B86)	0 (0x2710)	-0.97 (0x1F40)
Rx Power (dBm)		-5.99 (0x09D5)	-7 (0x07CB)	-30 (0x000A)	-33 (0x0005)

Block-Diagram-of-Transceiver

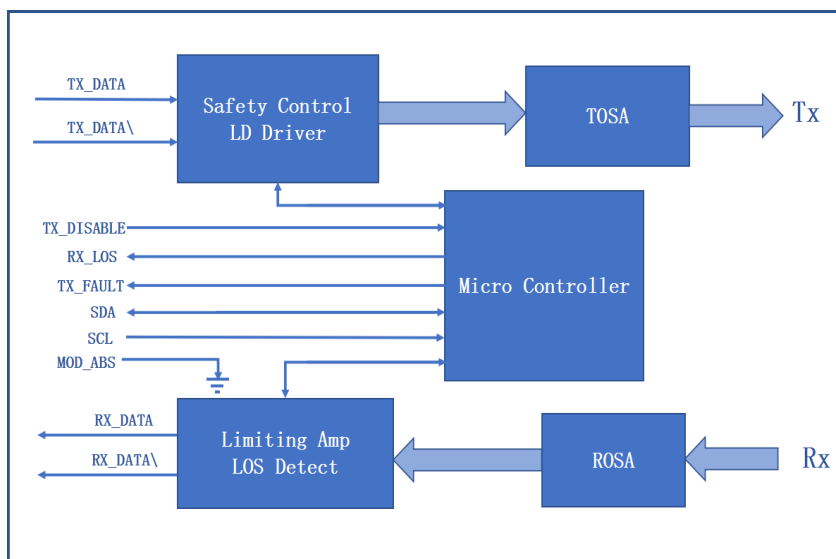

Functions Description

The transmitter consists of a laser driver chip and a TOSA (light-emitting component). The TOSA includes a DFB laser, a TEC, and a backlight diode. TEC (Thermo Electric Cooler) Controls the temperature of the laser tube. When a temperature is set, the TOSA temperature of the module will remain unchanged through the control of the TEC. The wavelength of the module laser tube is related to the temperature of the laser tube. The module wavelength can be set by setting the TOSA temperature. When stable, the module has excellent wavelength stability. The electrical signal enters the optical module from the serial electrical interface and is then input to the laser driver chip. The laser driver chip supplies the bias current and the modulation current to the laser. The laser driver chip simultaneously uses an automatic optical power control (APC) feedback loop to maintain a constant average optical power of the laser output. The purpose is to eliminate the change of the output optical signal due to temperature changes and aging of the light source device. When the transmitter enable pin (TX_Disable) is high (TTL logic “1”), the laser output is turned off. When TX_Disable is low (TTL logic “0”), the laser will turn on within 1ms. When the transmitter fault signal (TX_Fault) is reported as high, indicates a transmitter failure caused by the transmitter’s bias current or transmitted optical power or laser tube temperature exceeding a preset alarm threshold. Low indicates normal operation.

The receiver consists of a ROSA (light-receiving component) and a limiting amplifier chip, ROSA includes a APD photodetector and a transimpedance amplifier chip. The ROSA detects the incident optical signal, converts the optical signal into an electrical signal, and outputs the electrical signal to the limiting amplifier. The electrical signal is further amplified by the limiting amplifier, then outputs a fixed-amplitude electrical signal to the host. When the amplitude of the electrical signal received from the incident light conversion of the opposite optical transceiver module is lower than the set threshold, the module reports that the received signal is lost, the RX_LOS pin is high (logic “1”), which can be used to diagnose whether the physical signal is normal. The signal is operated in TTL level. The

microprocessor inside the module monitors the module's operating voltage, temperature, transmitted optical power, received optical power, and laser bias current value in real time. The host acquires this information over a 2-wire serial bus.

Dimensions

Module Weight: 16.5g

Dust Cap Weight: 0.95g

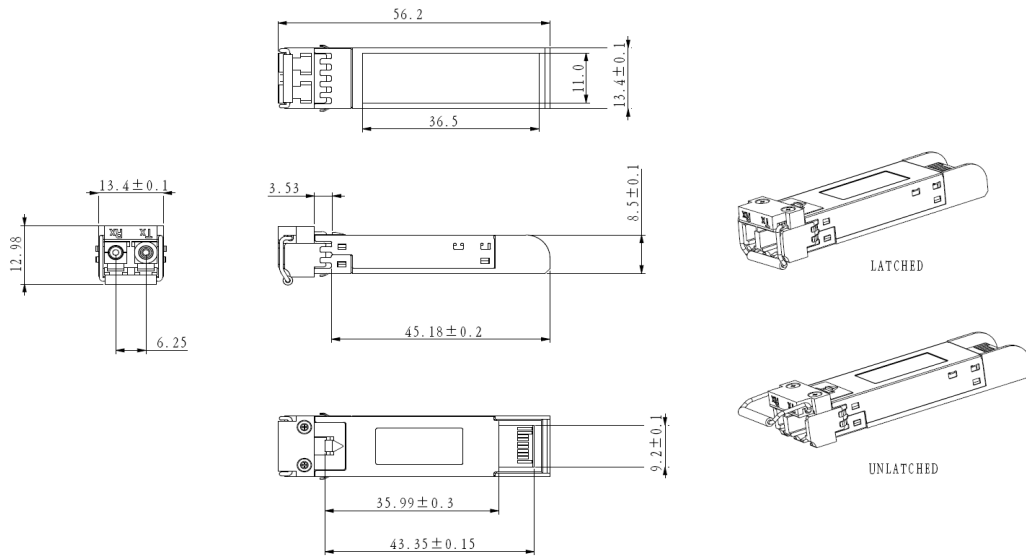

ALL DIMENSIONS ARE ±0.2mm UNLESS OTHERWISE SPECIFIED
UNIT: mm

Electrical Pad Layout

Top of Board

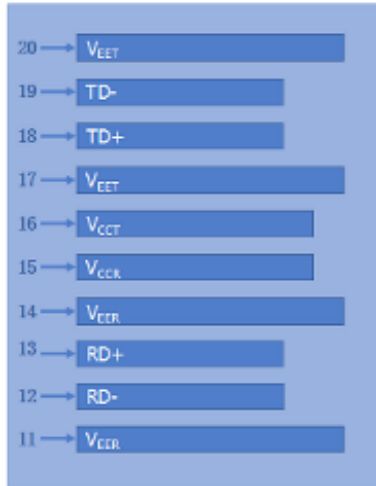

Bottom of Board

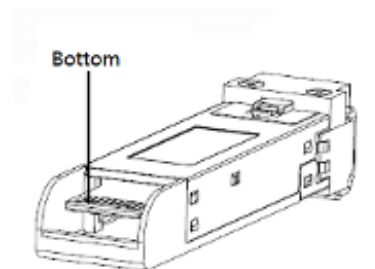
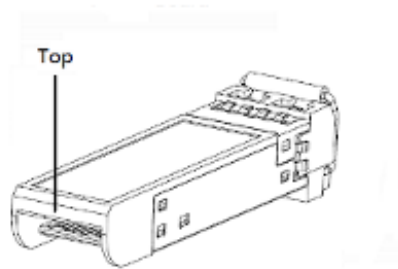
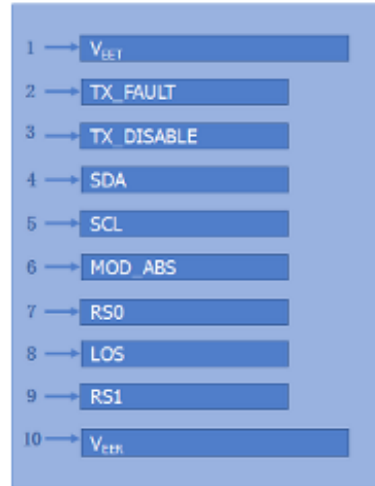

Pin Assignment

PIN #	Symbol	Description	Remarks
1	V _{EET}	Transmitter ground (common with receiver ground)	1
2	TX_FAULT	Transmitter Fault	
3	TX_DISABLE	Transmitter Disable. Laser output disabled on high or open	2
4	SDA	2-wire Serial Interface Data Line	3
5	SCL	2-wire Serial Interface Clock Line	3
6	MOD_ABS	Module Absent. Grounded within the module	3
7	RS0	No connection required	
8	LOS	Loss of Signal indication. Logic 0 indicates normal operation	4
9	RS1	No connection required	1
10	V _{EER}	Receiver ground (common with transmitter ground)	1
11	V _{EER}	Receiver ground (common with transmitter ground)	1
12	RD-	Receiver Inverted DATA out. AC coupled	
13	RD+	Receiver Non-inverted DATA out. AC coupled	
14	V _{EER}	Receiver ground (common with transmitter ground)	1
15	V _{CCR}	Receiver power supply	
16	V _{CCT}	Transmitter power supply	
17	V _{EET}	Transmitter ground (common with receiver ground)	1
18	TD+	Transmitter Non-Inverted DATA in. AC coupled	
19	TD-	Transmitter Inverted DATA in. AC coupled	
20	V _{EET}	Transmitter ground (common with receiver ground)	1

Notes:

1. Circuit ground is isolated from chassis ground
2. Disabled: T_{DIS}>2V or open, Enabled: T_{DIS}<0.8V
3. Should Be pulled up with 4.7k –10k ohm on host board to a voltage between 2V and 3.6V
4. LOS is open collector output

References

1. [Small Form Factor Pluggable \(SFP\) Transceiver Multi-Source Agreement \(MSA\), INF-8074i.](#)
2. [Digital Diagnostics Monitoring Interface for Optical Transceivers –SFF-8472.](#)
3. Bellcore GR-253 and ITU-T G.957 Specifications.